

Dialog 4222 Office / Dialog 3211 & 3212

BusinessPhone Communication Platform

User Guide



A/STRA

EN/LZTBS 170 321 R2A

© Aastra Telecom Sweden AB 2008. All rights reserved.

Welcome	4
Description	6
Incoming Calls	18
Outgoing Calls	22
During Calls	33
Call List	40
Call Metering	42
Call Forwarding	44
Absence Information	50
Mailbox System	54
System Phonebook	64
Security	66
Group Features	68
ISDN Facilities	73
Other Useful Features	78
Settings	87
Accessories	98
Useful Hints	104
Installation	105
Glossary	115
Index	118

Welcome

Welcome to the User Guide for the Dialog 4222 Office, Dialog 3212 Standard and Dialog 3211 Economy^{plus} phones in the BusinessPhone Communication Platform from Aastra. The BusinessPhone Communication Platform consists of BusinessPhone 50, BusinessPhone 128i and BusinessPhone 250.

The features described in this User Guide are related to version 7.0 or higher of the BusinessPhone Communication Platform. Some might not work in earlier versions of the system and/or might be protected by a license that has to be bought separately. The User Guide describes the facilities of the BusinessPhone Communication Platform and the Dialog 4222 Office, Dialog 3212 Standard and Dialog 3211 Economy^{plus} phones with a default programming. There may be some differences in the way your phone is programmed. Please consult your system administrator if you need further information.

The latest version of this User Guide can also be downloaded from: <http://www.aastra.com>

Note: *Dialog 4222 Office / Dialog 3211 & 3212 are system telephones, i.e. they can only be used for an Aastra private branch exchange that supports this type of telephone.*

Function descriptions that do not include speaking in the handset, are described as off-hook, if nothing else is stated. Instead of pressing the Clear key, you can always replace the handset. The Dual-Function keys allow two functions to be combined on the same keys.

Copyright

All rights reserved. No parts of this publication may be reproduced, stored in retrieval systems, or transmitted in any form or by any means, electronic, mechanical, photocopying, recording or otherwise, without prior written permission of the publisher except in accordance with the following terms.

If this publication is made available on Aastra media, Aastra gives its consent to downloading and printing copies of the content provided in this file only for private use and not for redistribution. No parts of this publication may be subject to alteration, modification or commercial use. Aastra will not be liable for any damages arising from use of an illegal modified or altered publication.

Aastra is a registered trademark of Aastra Technologies Limited. All other trademarks mentioned herein are the property of their respective owners.

Warranty

Aastra MAKES NO WARRANTY OF ANY KIND WITH REGARD TO THIS MATERIAL, INCLUDING, BUT NOT LIMITED TO, THE IMPLIED WARRANTIES OF MERCHANTABILITY AND FITNESS FOR A PARTICULAR PURPOSE. Aastra shall not be liable for errors contained herein nor for incidental or consequential damages in connection with the furnishing, performance or use of this material.

Declaration of Conformity

Hereby, Aastra Telecom Sweden AB, SE-126 37 Hågersten, declares that this telephone is in conformity with the essential requirements and other relevant provisions of the R&TTE directive 1999/5/EC.

Details to be found at: <http://www.aastra.com/sdoc>



Description

Dialog 4222 Office

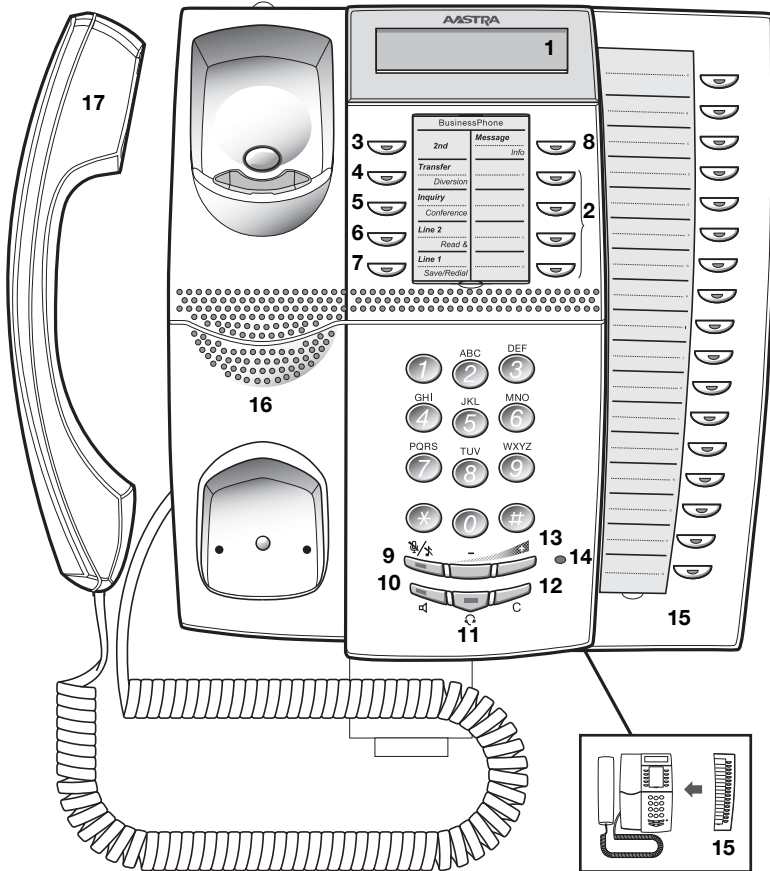

- 1 Display**
2x20 characters. See section [“Display info” on page 15](#).
- 2 Dual-Function programmable keys**
Storing numbers, program functions. See section [“Settings” on page 88](#).
- 3 2nd**
Key for access to secondary key functions (These functions are stated on the second line of the corresponding key).
- 4 Transfer / Diversion**
 - a. Transfer an ongoing call. See section [“During Calls” on page 34](#).
 - b. Activate/Deactivate diversion. See section [“Call Forwarding” on page 45](#).
- 5 Inquiry / Conference**
 - a. To make an inquiry to an internal or external party.
 - b. To establish a telephone conference.See section [“During Calls” on page 34](#).
- 6 Line 2 / Read &**
 - a. Line key 2 for in and outgoing calls.
 - b. Read information. See section [“Absence Information” on page 51](#).
- 7 Line 1 / Save/Redial**
 - a. Line key 1 for in and outgoing calls.
 - b. Save or redial an external number. See section [“Outgoing Calls” on page 23](#).
- 8 Message / Info**
 - a. To send and receive messages. See section [“Send Message” on page 40](#) and [“Mailbox System” on page 55](#)
 - b. To enter information. See section [“Absence Information” on page 51](#).
- 9 Mute**
To switch the microphone on or off. See sections [“During Calls” on page 34](#) and [“Silent ringing” on page 21](#).
- 10 Loudspeaker on/off**
To switch the loudspeaker on or off. See section [“During Calls” on page 34](#).
- 11 Headset key**
See section [“Headset - Dialog 4222 Office” on page 101](#).
- 12 Clear**
To disconnect calls or to clear the display in programming.

13 Volume control
To adjust the volume. See section “Settings” on page 88.

14 Microphone

15 Optional key panel
17 Dual-Function programmable keys.

Note: Use only an optional key panel of type DBY 419 01.

16 Loudspeaker

17 Handset with hearing aid function

Please note: The handset may attract and retain small metal objects in the earcap region.

Dialog 3212 Standard / Dialog 3211 Economyplus

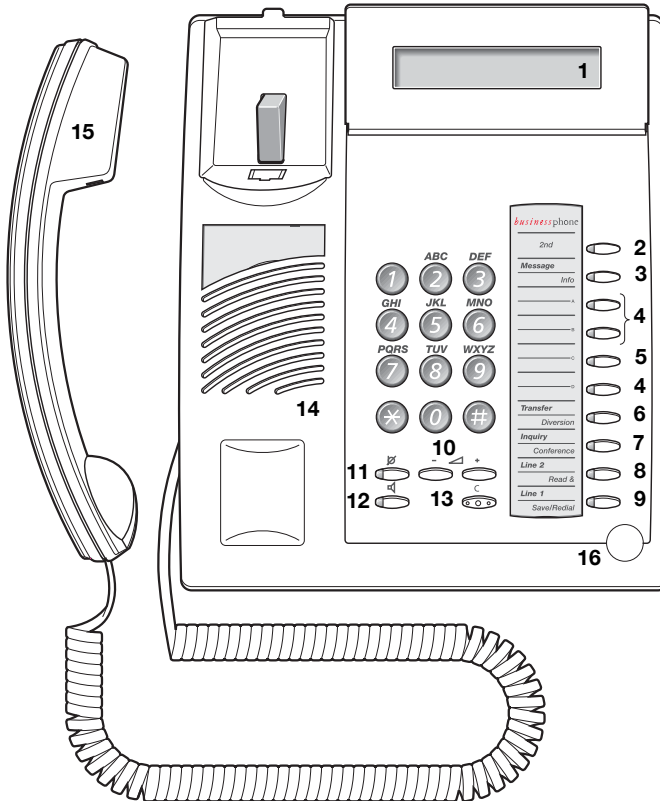

Note: The graphic above is valid for the Dialog 3212 Standard as well as the Dialog 3211 Economyplus telephone. The Economyplus telephone is not equipped with a display.

- 1 Display (Standard telephone only)**
2x20 characters. See section [“Display info” on page 15.](#)
- 2 2nd**
Key for access to secondary key functions (These functions are stated on the second line of the corresponding key).
- 3 Message / Info**
 - a. To send and receive messages. See section [“Send Message” on page 40](#) and [“Mailbox System” on page 55.](#)
 - b. To enter information. See section [“Absence Information” on page 51.](#)
- 4 Dual-Function programmable keys (A-D)**
Storing numbers, program functions. See section [“Settings” on page 88.](#)
- 5 Dual-Function programmable key (C) / Headset key**
 - a. Storing numbers and program functions.
 - b. The Headset function is only available with option unit (DBY 410 02) installed. The Headset key is programmed by the system administrator. See section [“Accessories” on page 99.](#)
- 6 Transfer / Diversion**
 - a. Transfer an ongoing call. See section [“During Calls” on page 34.](#)
 - b. Activate/Deactivate diversion. See section [“Call Forwarding” on page 45.](#)
- 7 Inquiry / Conference**
 - a. To make an inquiry to an internal or external party.
 - b. To establish a telephone conference.
See section [“During Calls” on page 34.](#)
- 8 Line 2 / Read & (Standard telephone only)**
 - a. Line key 2 for in and outgoing calls.
 - b. Read information (Standard telephone only). See section [“Absence Information” on page 51.](#)
- 9 Line 1 / Save/Redial**
 - a. Line key 1 for in and outgoing calls.
 - b. Save or redial an external number. See section [“Outgoing Calls” on page 23.](#)
- 10 Volume control**
To adjust the volume. See section [“Settings” on page 88.](#)
- 11 Mute**
To switch the microphone on or off. See section [“During Calls” on page 34.](#)

12 Loudspeaker on/off

To switch the loudspeaker on or off. See section “[During Calls](#)” on [page 34](#).

13 Clear

To disconnect calls or to clear the display in programming.

14 Loudspeaker**15 Handset with hearing aid function**













Please note: *The handset may attract and retain small metal objects in the earcap region.*

16 Microphone

Phone keys Dialog 4222 / Dialog 3211 & 3212





This table gives you an overview of the different key design of the Dialog 4222 Office, the Dialog 3212 Standard and the Dialog 3211 Economy*plus*. In this user guide you will only find illustrations of the Dialog 4222 keys.

If you are using the Dialog 3212 Standard or the Dialog 3211 Economy*plus*, please refer to the table below to find out the appropriate key combination.

Key	Dialog 4222	Dialog 3211 Dialog 3212
Clear		
Headset		Headset 
Loudspeaker		
Mute		
Programmable Function key		
Volume		

Lamp indications

The key lamps on your telephone indicate with different signals the traffic state of the ongoing call or function.

	Extinguished lamp	The function is not active.
	Steady light	The function is active.
	Slowly flashing lamp	The line (or function) is put on hold.
	Rapidly flashing lamp	An incoming call or message waiting.
	Light with short breaks	Ongoing call.

Display info

Note: *This section only applies to the Dialog 4222 Office and the Dialog 3212 Standard telephone.*

The display assists your actions on the phone with step-by-step instructions. When your phone is idle, the upper line shows general information. The lower line shows your name and extension number.

```
12 May 10:35 +15°
ANDERSEN A 200
```

During an internal call the lower line shows the other party's name, extension number and status.

```
12 May 10:35 +15°
BURNES B 201 S
```

If you make an internal call to someone who has activated a diversion, the upper line shows the name and extension number of the person you called and the lower line shows where the call is diverted.

```
CHAMBERS D 203
BURNES B 201 F
```

During an incoming external call the lower line shows the other party's number and status (if connected to an ISDN-trunk line).

```
12 May 10:35 +15°
431811005446 S
```

If a name is available to the external caller's number in your system, it is shown alternating to the number. (Please contact your system administrator whether the feature name presentation is available in your system).

Status information

Status information during internal calls:

NB	The called number is blocked.
B	The called extension is busy.
C	Incoming call.
F	The called extension is free.
F2	The called extension is free on Line 2.
I	Intrusion.
P	The called extension has put the call on hold.
R	Recall from an individually call that has been put on hold.
S	Speech mode.
NU	Number unknown.
W	Camp-on mode.
&	The called extension has text info stored.
%	The called extension has Voice info stored.
C!	Missed calls
+15°^	Indicates outside temperature and tendency (up or down) if your telephone system is equipped with optional temperature sensor.

Tones

Tones are audible in the handset.

Dial tone

(System ready to accept digits)



Special dial tone

(System ready to accept digits, active diversion on telephone)



Ring tone

(Ringing signal to called party)



Special ring tone

(Ringing signal to Line 2)



Busy tone

(Called party is busy)



Number unobtainable tone

(Called number not accessible or vacant)



Call Waiting tone



Blocking tone

(Call cannot be executed due to congestion or called party blocked)



Verification tone

(Verification that ordered function is accessed)





Intrusion tone

(Sent to all parties during Intrusion)



Signals

Ringing signals are emitted from the phone.

Internal ringing signal		- repeated after 4 s
External ringing signal		- repeated after 4 s
Automatic Callback signal		

Note: *The tones and ringing signals in this guide refer to the standard system but may vary between countries.*

Incoming Calls

Internal calls

A ringing signal and a flashing lamp indicate an incoming call. The display shows the number and the name of the internal caller (Dialog 4222 Office / Dialog 3212 Standard telephone).

External calls

A ringing signal and a flashing lamp indicate an incoming call. If you are connected to a digital trunk line (ISDN), the display shows the number of the external caller and in case of diversion in the public net the display shows the number of the diverted as well as the calling party, see also section "[ISDN Facilities](#)" on page 74 (Dialog 4222 Office / Dialog 3212 Standard telephone). A trunk line is the same as an external line.



Answer calls

Lift the handset.

Handsfree

Line 1 

Press without lifting handset.

Or:



Press without lifting handset.

You are connected to the caller via the loudspeaker and microphone.



Press to terminate a handsfree call.

To another extension

You can answer a call to another extension from any phone in your office.



Call the ringing extension.

You receive busy tone.

6

Press.

Allow calls on Line 2

If you also want to receive calls while speaking you first need to program Free On 2nd Access on a programmable key. [See section "Settings" on page 88.](#)

Free On 2nd
Access



Press to activate / deactivate Free On 2nd Access (pre-programmed).

When Free On 2nd Access is active the lamp lights and you can receive calls while speaking.

Line 2 



Answer a second call

You are on the phone, when a muted ringing signal and a Line key flashes to indicate a new incoming call:

Press the flashing Line key.

The first call is put on hold.

To switch back to the first call:

Line 1 

Press the first Line key.

The second call is put on hold. You are connected to the first caller.

Press if you want to terminate the ongoing call.

Silent ringing

This function is useful if you do not want to be disturbed by the ringing of the telephone.

Dialog 4222 Office / Dialog 3212 Standard:

Incoming calls will only be indicated on the display and by the flashing Line key.

Dialog 3211 Economyplus:

Incoming calls will only be indicated by the flashing Line key.

Note: For the Dialog 3212 Standard this function requires the release number R7B or higher; for the Dialog 3211 Economyplus this function requires the release number R6B or higher, see the underside of your telephone.



In idle mode:

Press to mute the ringer for incoming calls.

Save and redial incoming calls

When you receive an incoming external call, you can save the number in order to redial it easily (the number can contain 24 digits maximum). Previously saved number is erased.

Save number

Before you quit the call:

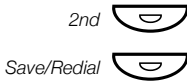

Press.

Press to save the dialled number.

Redial number



Press.

Press to redial the saved number.

Outgoing Calls

Sometimes you make a call but the person is not available. These functions will help you in your attempts to establish contact with the called party.

Make calls

How to make internal and external calls.



Lift the handset



Enter any directory number to make an internal call.

Or:



Enter the digit(s) for external line access and the desired public number.

***Note:** Which digit to press for external line access depends on the configuration of the system.*

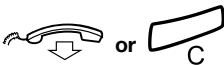

To end the call.

***Note:** You can make your calls faster, using Common Abbreviated Numbers and by programming your own Abbreviated Numbers.*

Handsfree

Without lifting the handset, just press a Line key, or the Loudspeaker key, or the first digit of the number. The call is in handsfree mode, via the loudspeaker and microphone.

Last External Number Redial

When you initiate an external call the system automatically stores all the dialed digits, irrespective of whether the call was successful or not. See also section "[Automatic Redial](#)" on page 25.

Press to redial the last dialed external number.

The display will show the dialed number.

Save external number

When you make an external call, you can save the number in order to redial it easily. Previously saved number is erased.

Save number

Before you quit the call:



Press.

Press to save the dialed number.

Redial number



Press.

Press to redial the saved number.

Automatic Callback

You call an extension and receive busy tone or get no answer.

5

Press.

Verification tone.

Note: *The number for Automatic Callback may differ from country to country.*

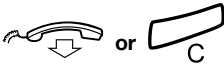

Replace the handset or press to finish the procedure.

You are called back if the extension finishes the ongoing call or the next time the extension finishes a new call. You have to answer within eight seconds otherwise the Callback service is cancelled.



Lift the handset when you are called back.

(You can also press the Line or Loudspeaker key to answer in handsfree mode.)

Automatic Redial

If you call an external number and receive busy tone or get no answer, you can instruct the system to automatically redial the number until it is available.

Note: *This feature could be restricted. Ask the system administrator for the availability.*

This function is activated via Function keys, so you first have to program a programmable key (one key required per number). See [section "Program a function" on page 89](#). You can activate Automatic Redial on up to four external numbers at the same time.

Activate

During the call:

Press to activate (pre-programmed).

The Automatic Redial lamp is rapidly flashing and is lit when the request is stored and activated. Verification tone.

Replace the handset or press to finish the procedure.

You are called back if the called number finishes the ongoing call or the next time the extension finishes a new call. On the Dialog 4222 Office and the Dialog 3212 Standard the display shows:

Automatic
Redial1

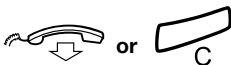



Lift the handset when you are called back.

(You can also press the Line or Loudspeaker key to answer in handsfree mode.)

Notes: *It is not possible to do a new request on a key holding an already activated request until the existing one is cancelled.*

When the Automatic Redial lamp is rapidly flashing, your telephone is busy and you cannot receive or make new calls.

The number of redial attempts and how long the function is active is programmed by your system administrator.

If you have activated a diversion on your telephone, this function is not available.

If Tandem configuration is activated, the secondary telephone cannot use this function. See section “[Tandem configuration](#)” on page 79.

Automatic Redial1



Cancel

Press the relevant programmable key to cancel the Automatic Redial request (pre-programmed).

Note: *Depending on system programming, the Automatic Redial request could be cancelled automatically.*

Pause

It is possible to pause all of your successfully activated requests by programming a separate pause key, see section “[Program a function](#)” on page 89.

Pause auto redial



Press to pause (pre-programmed).

The requests are paused and the key lamps of the Automatic Redial keys are flashing slowly.

Pause auto redial



Press to resume Automatic Redial (pre-programmed).

Busy extension

You call an extension and receive busy tone.

Camp-on

You can notify a busy extension of your call by a muted ringing call.

4 Press to camp-on.

Keep the handset off hook. When the called extension replaces the handset, it will be called automatically.

Notes: *If you receive the busy tone again, the desired extension does not allow Camp-on.*

The number for Camp-on may differ from country to country, see table "Alternative programming for Automatic Callback, Camp-on, Intrusion" on page 92.

Intrusion

You can intrude on an ongoing call on a busy extension (if this function is allowed).

8 Press to intrude.

Intrusion tone is heard and a three-party call is established. When the called extension replaces the handset and you keep off hook, the called extension will be recalled automatically.

Notes: *If you still hear the busy tone, your extension does not have the authority to intrude or the desired extension is protected against Intrusion.*

The number for Intrusion may differ from country to country, see table "Alternative programming for Automatic Callback, Camp-on, Intrusion" on page 92.

Diverted extension

Bypass Call Forwarding makes it possible to call a specific extension, even if Call Forwarding is activated on this extension.

✳ 6 0 ✳



Press.

Enter extension number.

#

Press.

You will be connected to the specified extension, regardless of which type of Call Forwarding the called extension has activated.

Abbreviated Numbers

By using Abbreviated Numbers, you can make calls simply by pressing a few keys. Frequently used external numbers are stored as Common Abbreviated Numbers in the exchange.

Your personal most frequently used external numbers - called Individual Abbreviated Numbers - can be stored and used on the 2nd layer of the programmable keys on the telephone, on the optional key panel or on the keys 0 to 9.

Note: Functions that you activate/deactivate via a dial code, e.g. *32* and #32# for Reminder, can also be stored as Individual Abbreviated Numbers.

You have two options to program an Individual Abbreviated Number or a function:

Option 1 - Via a programmable key

4 Individual Abbreviated Numbers can be programmed on the programmable keys on the phone and 17 on the optional key panel (Dialog 4222 Office only). See section "[Individual Abbreviated Numbers via a programmable key](#)" on page 30.

Option 2 - Via the keypad

10 Individual Abbreviated Numbers can be programmed on the keys 0 to 9. See section "[Individual Abbreviated Numbers via the keypad](#)" on page 31.

Additionally, you can program the 4 programmable keys on the telephone (see Option 1).

Notes: *This procedure is very useful if you are not using a key panel.*

If you are using a Dialog 4222 Office with the optional key panel, all Abbreviated Numbers that are programmed via the keypad, will be stored on the first 10 programmable keys on the key panel, see graphic below:

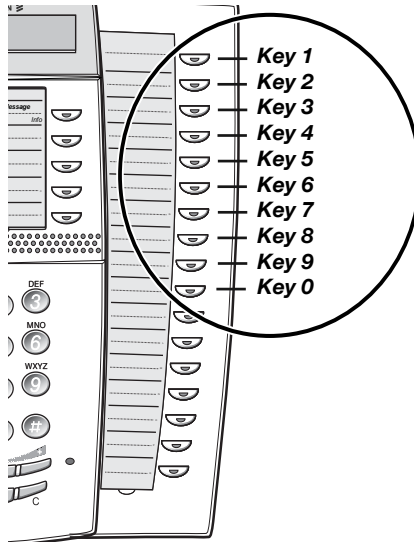

Common Abbreviated Numbers

External numbers are stored centrally in your BusinessPhone Communication Platform. Common Abbreviated Numbers can be dialed from every extension that has the authority to do so.



Enter the Common Abbreviated Number.

Please refer to your telephone directory.

Individual Abbreviated Numbers via a programmable key

You can program and activate your most frequently used external numbers on the 2nd layer of a programmable key. This procedure can also be used if you want to program a function that is activated/deactivated via a dial code.

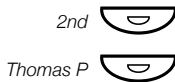

Press.

Press to make a call or activate a code (pre-programmed).

[Program Individual Abbreviated Number](#)

How to program external numbers or dial codes on the programmable keys.

00

Press to enter the programming mode.



Press.



Press a programmable key.



Enter the digit(s) for external line access and the public number.

Note: Which digit to press for external line access depends on the configuration of the system. The number can consist of up to 24 digits.

Note: If your public network requires waiting for a second dial tone, press the key 2nd followed by the key 2.

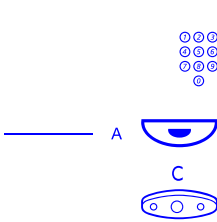

Or:

Enter a dial code (maximum 4 digits).

Press the programmable key again.

Press to finish programming.

Note: *The Dual-Function keys allow Individual Abbreviated Numbers and other functions e.g. Dial-by-Name to be combined on the same keys. You can remove the transparent cover in order to write the names beside the keys. Put the name referring to the Individual Abbreviated Number in the field below the line to indicate that it is the secondary function.*

Individual Abbreviated Numbers via the keypad

You can program and activate your most frequently used external numbers via the keypad.

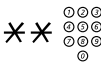

Press and enter the Abbreviated Number.

A number between 0 and 9.

Program Individual Abbreviated Number

How to program external numbers on the keys 0 to 9.



Press to enter the programming mode.



Enter an Abbreviated Number between 0 and 9 and press.



Enter the digit(s) for external line access and the external number.

The number can consist of up to 24 digits.

Note: *If your public network requires waiting for a second dial tone, press *.*



Press.

Press to finish programming.

Cancel one specific Individual Abbreviated Number

5 1 *

Press.



Enter an Abbreviated Number between 0 and 9 and press.

Cancel all Individual Abbreviated Numbers

5 1

Press.

Confirmation tone.

Dial-by-Name

You can program and activate directory numbers (extensions and Common Abbreviated Numbers) on the programmable keys.

Head Office



Press to make a call (pre-programmed).

Program Dial-by-Name

How to program an internal directory number on a programmable key.

*** 0 0 ***

Press to enter the programming mode.



Press a programmable key.

1 0

Press.



Press the programmable key again.



Enter the number.

You can use any directory number, e.g. a Common Abbreviated Number or a colleague's extension number.

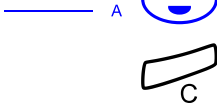

Press the programmable key again.

Press to finish the procedure.

During Calls

The BusinessPhone Communication Platform allows you to handle calls in many different ways. You can switch between handset and handsfree/group conversation, mute the microphones, make an inquiry, transfer the call, create a Conference or put the call on hold to perform other tasks.

Group Listening

You have an ongoing conversation via the handset.



Press to switch the loudspeaker on or off.

When the lamp lights, the loudspeaker monitors the call.

Note: You can adjust the volume, see section “Settings” on page 88.

From handset to handsfree

You have an ongoing conversation via the handset.



Press to switch the loudspeaker on.

You are now in the Group Listening mode.



Replace the handset.

Handsfree conversation.

Note: You can adjust the volume, see section “Settings” on page 88.



Press to end the call.

From handsfree to handset

You have an ongoing handsfree conversation.



Lift the handset.

Conversation via the handset.

Mute

You have an ongoing conversation.



Press to switch the microphone on or off.

When the lamp lights, the caller will not be able to hear the conversation in your room.

Inquiry

During an ongoing conversation you wish to make an inquiry to an internal or external party.

Inquiry 

Press.

Or:

Line 2 

Press Line 2.

The first call is put on hold (the lamp flashes slowly).



Enter the number of the third party.

When the third party answers you can switch between the calls, create a Conference and end one of the calls.



Press to end the Inquiry call.

The second call is disconnected.

Line 1 

Press to retake the first call.

You are now connected to the first party.

Refer Back

You have an ongoing conversation on e.g. Line 2 and want to refer back to the call that is put on hold on Line 1. The lamp of the call put on hold flashes.

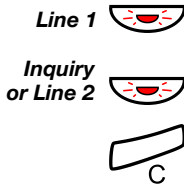

Press to put the second call on hold.

First call is connected.

Press to put the first call on hold.

Second call is connected.

Press to end the ongoing call.

Transfer

You have an ongoing internal or external conversation and you want to transfer the ongoing call.

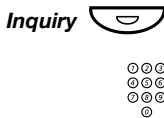

Press.

Enter the number of the third party.

You can transfer the call before answer or wait for answer.

Note: *Make sure, that you are connected to the desired party. Please read the notes and warnings in section “Useful Hints” on page 105.*

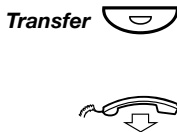

Press.

Or:

Replace the handset.

The call is transferred. External calls might only be transferred with the Transfer key, if this state of connection is allowed by the System programming.

Transfer to a busy extension

You can even transfer calls to busy extensions. The other party will hear a muted signal (Camp-on), and the call will be extended, as soon as the ongoing call is terminated (if Camp-on is allowed).

Callback

You are called back, if you have transferred an external call and the other extension has not answered the call within a certain time. Your telephone will ring again.

Call Waiting

If you hear the Call Waiting tone during an ongoing conversation, another person is trying to contact you.

To terminate the ongoing call and answer the waiting call



Replace the handset to finish the ongoing call.

The waiting call is signalled on your phone.



Lift the handset to answer the new call.



Or:

Press and replace the handset to answer in handsfree mode.

Conference

You have an ongoing conversation and you want to establish a telephone conference.

Inquiry 

Press.

Or:

Line 2 

Press.



Enter number of the third party.

2nd 

Press.

Conference 

Press to establish a three party conference.

Now you have established a three party conference. To indicate the Conference, all Conference members will hear a periodical Conference tone.

Repeat the procedure to include other persons into the Conference.

In this way, you can include up to six parties in a conversation. How many of them can be external callers depends on the programming of the system.

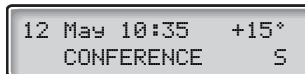

Individual Hold

You have an ongoing conversation, i.e. the Line 1 key is lit. Now you want to put the ongoing call on hold for a short while.



Press the Line key.

The lamp flashes slowly.



Press again to retake the call that has been put on hold.

Common Hold



Press (pre-programmed).

The Line key lamp flashes slowly. The call can be picked up on any extension within one minute, or if not it will recall on the holding extension.



Press to pick-up on own extension.

Or:

Pick-up on another extension:



Enter the number of the extension that put the call on hold.

6

Press.

Send Message

To send a message to an extension when you receive busy tone or get no answer.

```
12 May 10:35 +15°
BURNES B 201 B
```

Message  #

Callback message

Press to send a Call Me message.

Voice

To send a Voice message.

Message 

Press.

9

Press and speak a Voice message.

Press to play-back and listen to your recording.

9

Press and speak to re-record.

#

Press to send.

Call List

The Call List includes a complete history of recently made calls. It offers access to previously dialed/received, internal/external numbers

The Call List provides following options:

- Indication of the total number of calls (maximum 20)
- Calling or erasing the listed numbers
- Scrolling through the list
- Indication of time and date of the calls
- Indication of the number of call attempts

In case of missed and unchecked calls the display shows C!

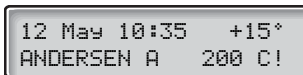

```
12 May 10:35 +15°  
ANDERSEN A 200 C!
```

Retrieve calls

To see the first entry in the Call List:

✖ 48#

Press.

The display shows e.g.:

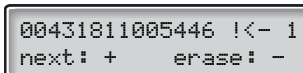

```
00431811005446 !<- 1  
next: + erase: -
```

Incoming/outgoing calls are shown as:

[<- incoming call answered

!<- incoming call not answered = missed call

[>- outgoing call

1-20 indicates the position in the list (maximum 20 entries)

If a name is available to the external caller's number in your system, it is shown alternating to the number. (Please contact your system administrator whether the feature name presentation is available in your system)

Note: *If you do not react within 30 seconds the display reverts to idle state. If you want to leave the function before the time-out, press the Clear key.*

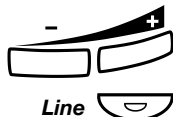

Press the Volume Up key to scroll through the list.

Press to call the selected number.

When the call is successful, the number is automatically removed from the Call List. The system automatically adds the digit(s) for external call access.

Note: *If digit(s) for external call access has not been defined for your Call List, contact your system administrator.*

Show date, time and call attempts for the selected call

When you are retrieving calls from your Call List.

1

Press to see the date and time for the selected call.

You will see when the call was dialed/received and how many times the same call was sent/came in.

```
12 May 08:22 12x
return:1
```

1

Press to return to the previous display.

Erase calls from the Call List

When you are retrieving calls from your Call List.



Press the Volume Down key to erase the selected call.

The call is erased from the list and the next call is displayed. The display will inform you if there are no more calls in the list.



Exit the Call List

Press to exit the Call list.

Call Metering

Note: *This section only applies to the Dialog 4222 Office and the Dialog 3212 Standard telephone.*

When the BusinessPhone Communication Platform is provided with metering information from the public net, the call metering function can be used to check the cost of outgoing calls. The BusinessPhone Communication Platform offers several options to obtain this information.

Cost Indication

During an outgoing external conversation the display shows the actual cost. If you want to deactivate the Cost Indication.

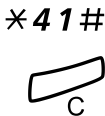

Press.

Verification tone, the Cost Indication is deactivated.

Press.

To activate the Cost Indication again for all further calls, repeat the procedure.

Cost of the last call

After finishing an outgoing external call, you have the possibility to see the cost of the last call.

✖ 46 #



Press.

The display shows the cost of the last call.

Press to finish the procedure.

Read out your own cost counter

This is useful, when you want to check the accumulated cost of your own counter.

✖ 45 #



Press.

The system shows the accumulated cost since the last reset.

Press to finish the procedure.

Call Forwarding

When you are not available to take calls or decide to answer your calls on another extension, it is useful to forward your calls to an alternate answering position. The alternate answering position can either be a pre-programmed one (a common one for: [Fixed Diversion](#), [Diversion when there is no answer](#) and [Diversion when caller receives busy tone](#)) or an individual one.

If you urgently need to talk to someone who has forwarded his calls, the system is also equipped with a bypass function.

Depending on the type of diversion you are also able to record your Personal Greeting, see section "[Change your Personal Greeting](#)" on page 59.

Note: *You can still make calls as usual.*

Diversion when there is no answer

If you are not available to answer incoming calls (internal or external), your system administrator can program your extension to automatically divert calls to a programmed diversion address (default time: 15 seconds).

Diversion when caller receives busy tone

If your extension is busy and you receive an incoming call (internal or external), your system administrator can program your extension to automatically divert the call to a programmed diversion address.

Fixed Diversion

This function directs your calls to a pre-programmed answering position (e.g. secretary).

Activate Fixed Diversion

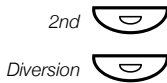

Press.

Press to activate diversion.

All calls to your extension are directed to a pre-programmed address. The display shows the actual diversion state.

```
12 May 10:35 +15°
DIVERSION 4736->5400
```



Cancel diversion

Press.

Press to cancel diversion.

Program Fixed Diversion address

If you need to program a new diversion address:

00

Press to enter the programming mode.

2nd 

Press.

Diversion 

Press.



Enter the new diversion address.

2nd 

Press.

Diversion 

Press.



Press to finish the procedure.

Individual Diversion

This feature gives you the possibility to divert your calls to internal and external positions, e.g. to any directory number, a colleague's extension, an external number or a Common Abbreviated Number (e.g. your mobile telephone).

Note: In order to prevent misuse, Individual External Diversion can be blocked for your extension, see section "Security" on page 67.

Program and activate Internal Diversion

Divert your calls to an internal position.



Press.



Press and enter the new directory number.

Any directory number.



Press.



Press.

Verification tone. The Diversion lamp lights and remains lit. The display shows the actual Follow-me state.



Press to finish the procedure.

You can make outgoing calls as usual. A special dial tone reminds you that Call Forwarding is active.

Note: An Individual Internal Diversion cannot be activated if an Individual External Diversion is already activated.

Cancel Internal Diversion



Press.



Press.

Individual Diversion is cancelled. The lamp extinguishes.

Program and activate a new External Diversion address

To set a new Individual External Diversion address:

*** 2 2 ***

Press.

0 

Enter the digit(s) for external line access and the new External Diversion address.

A maximum of 24 digits.

Note: Which digit to press for external line access depends on the configuration of the system.

Note: If your public network requires waiting for a second dial tone, press *****.

#

Press to activate the Individual Diversion.

Verification tone.



Press to finish the procedure.

Note: Before you leave, call your extension to check if the External Diversion has been set up correctly. This way you can make sure that the number has been programmed properly and that your calls will not be diverted to another person by mistake.

Cancel External Diversion

2 2

Press.



Press.

Note: The programmed diversion address is not removed from the memory, the diversion is just inactive.

Re-activate External Diversion

Divert your calls to an external position.

*** 2 2 * #**

Press to activate the programmed External Diversion.

You can make outgoing calls as usual. A special dial tone reminds you that Call Forwarding is active. The display shows that you have activated an External Diversion.



Press.

Follow-me

If you are in another room, you can still answer your calls by forwarding them to where you are. To activate Follow-me, Individual Diversion must be active on your telephone.

Activate Follow-me

Note: This procedure has to be executed from the telephone the calls are diverted to.

*** 2 1 ***

Press.



Enter your extension number and press.



Enter the new directory number and press.
Special dial tone.



Press to finish the procedure.

Cancel Follow-me

Follow-me and Individual Diversion can also be cancelled from the answering position.

2 1 *

Press.



Enter your extension number.

#

Press.
Dial tone.



Press to finish the procedure.

Absence Information

If you are not in the office for a certain period of time (e.g. meeting, vacation, lunch, illness), this feature allows you to inform your callers of the reason of your absence. External callers will be routed to the operator who also has access to your absence info.

Note: *When you have activated a diversion with a Personal Greeting, callers will receive this greeting even if you have activated the Absence Information, see section [“Change your Personal Greeting”](#) on page 59.*

You can inform your callers with:

1) Pre-defined texts

Enter the reason for your absence and the date and time of your return.

2) Voice information

Record a Voice message and name the reason of your absence.

Enter information

To store Text or Voice information.



Press.



Press.

When the information is activated, the Message/Info lamp shows a steady light. If a message arrives, the lamp starts flashing, see section [“Listen to Messages”](#) on page 58.

Select Pre-defined Text or Voice information.



Pre-defined texts

Enter Info Code and Completing Info (see table).

	Code	Completing Info
Time of return	1	hour (00-23) minute (00-59)
Date of return	2	month (01-12) day (01-31)
Lunch	3	back at, hour minute
Meeting	4	back at, hour minute
Vacation	5	back, month day
Illness	6	back, month day

#



Press to enter the information.

Press to finish the procedure.

The programmed absence info will be shown in the display. Internal callers receive the information on the display (or as spoken information to callers without display phone). External callers will be routed to the operator who also has access to your absence info.

Pre-defined texts example: Vacation, back June 27

2nd 

Press.

Info 

Press.

5

Enter the absence code.

0 6 2 7

Enter month and day.

#

Press.

Information active.

Voice information



Press.



Press.

9

Press and speak.

Press to play-back and listen to your recording.

9

Press and speak to re-record.

#

Press to activate.



Press to finish the procedure.

Internal callers will hear the information via the handset or the loudspeaker. External callers will be routed to the operator who also has access to your absent info.

Note: You can dial your own extension number if you want to check your information.

Change information

Erase information



Press.



Press.

0 #

Press to erase info.

Save information



Press.



Press to deactivate and save for later use.

Information is passive.



Press to finish the procedure.

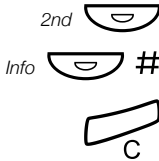

Use saved information

When the information is switched off:

Press.

Press to activate saved info.

The Message/Info lamp lights. Information is active.

Press to finish the procedure.

Receive information for diverted calls

Note: *This section only applies to the Dialog 4222 Office and the Dialog 3212 Standard telephone.*

A colleague, Andersen, has programmed diversion to your extension. You answer a call to Andersen on your phone. The sign '&' or '%' indicates that Andersen has Text or Voice info programmed.

Text info programmed

ANDERSEN A	200&
BURNES B	201 S



Press.

Press and hold to read text info.

Voice info programmed

ANDERSEN A	200%
BURNES B	201 S

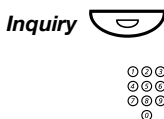

Press.

Enter Andersen's number to receive the Voice information.

Mailbox System

While you are away from the office, callers can leave messages in your individual or in a common mailbox, which can be used by more than one user.

You are also able to configure your individual mailbox with your personal greeting, see section [“Change your Personal Greeting” on page 59](#).

The first time you enter the mailbox system (only possible from own extension), you might be requested to change your password if it is default (0000). See section [“Change Password” on page 62](#) or follow the voice announcements.

Note: *To use the mailbox system, your extension has to be authorized by the system administrator.*

Activate the Mailbox

Divert your extension to your individual or to the common mailbox.

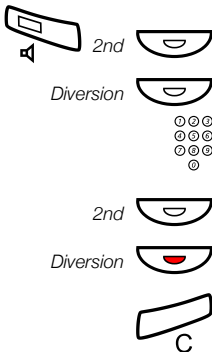

Press.

Press.

Enter the number of the individual or common mailbox.



Ask the system administrator for the defined numbers.

Press.

Press.

Press to finish the procedure.

When the diversion is activated, the Diversion lamp shows steady light.

Note: For daily use, it is recommended to ask your system administrator to define the personal or common mailbox as your pre-programmed diversion address. Once this is defined, you only have to press 2nd  + Diversion  to activate your mailbox.

The system administrator can also define whether or not the personal or common mailbox should be activated if you do not answer your phone after a certain time or if your extension is busy.

Deactivate the Mailbox

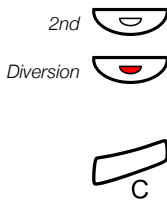

Press.

Press.

Verification tone.

Press to finish the procedure.

New incoming calls will be signalled on your phone again.

Note The mailbox is still active if is defined as pre-programmed diversion address for the feature [Diversion when there is no answer](#) and [Diversion when caller receives busy tone](#).

Access the Mailbox

The following mailbox functions can be accessed from your own extension, any other internal extension or from an external position (e.g. mobile phone)

- Listen to available messages
- Change your personal greeting *)
- Send messages *)
- Set up Outcall (External) Notification *) (configuration dependent)
- Change your password *)

*) not applicable for the common mailbox

Access the mailbox from your own extension

Message 

Press to access your individual mailbox

Or:

Common Mailbox 

Press to access the common mailbox (pre-programmed key).

Listen and follow the voice announcements.

***Note:** Depending on the configuration, you might be asked for your password before you can enter your mailbox.*

Access the mailbox from any other extension



Enter the directory number of the individual or common mailbox .

Listen and follow the voice announcements.

Access the mailbox from an external position (e.g. mobile phone)



Enter the public number of your company.



Enter the directory number of the individual or common mailbox.

Listen and follow the voice announcements.

Listen to Messages

Received messages are divided into the following three categories:

- New messages (not heard); indicated by a flashing message lamp and a special dial tone.
- Heard messages; indicated by a lighting message lamp and a special dial tone.
- Stored messages; not indicated.

Note: Messages are deleted from the system after a certain time. Please ask your system administrator regarding this.

Access the mailbox.

(See chapter “Access the Mailbox” on page 57.)

Listen and follow the voice announcements in the main menu.

Note: In the common mailbox there exists no main menu, therefor skip the next step.

1

Select to listen to available messages

Note: If there are no messages in your mailbox, the option to listen to your messages will not be available.



Select one of the three message categories (new, heard, stored).

Listen to your messages and follow the voice announcements in the dedicated menu.

- play message again
- forward a message
- get date and time info
- pause during play
- play previous message
- store message
- play next message
- erase message

Note: Voice messages will be heard. “Call me” messages will call the sender (these messages cannot be stored).



Press to finish the procedure.

Forward a Voice Message

A copy of your received voice messages (in the individual mailbox) can be forwarded to other mailbox numbers (individual or common). When you forward a voice message (heard or stored) to an individual mailbox, the mailbox number is the same as the extension number.

Note: *The forwarded message is a copy, i.e. it can be deleted without deleting the original message.*

There are no distribution list numbers available. Forwarding the same message to more than one mailbox must be done in single operations.

Change your Personal Greeting

Note: *This function is not applicable for the common mailbox*

Depending on the type of call diversion to the mailbox, you can leave three different personal greetings for the caller. You can activate a diversion when a caller receives busy tone, when there is no answer, or you can activate a fixed or individual diversion for all your calls.

Access the mailbox.

(See chapter "[Access the Mailbox](#)" on page 57.)

Listen and follow the voice announcements in the main menu.

2

Select to change your Personal Greeting.



Select the desired diversion type

Listen and follow the voice announcements in the main menu.

When you activate the diversion, the recorded greeting is played to the next caller.



Press to finish the procedure.

Note: *When you have activated a diversion with a Personal Greeting, callers will receive this greeting instead of your activated absence information.*

Send Messages via your Mailbox

Note: *This function is not applicable for the common mailbox*

With this function, the mailbox system allows you to record and send messages from your mailbox to any other internal mailbox without calling the respective mailbox owner. A recorded message can either be sent to one or to multiple mailboxes.

Note: *There are no distribution list numbers available. Sending the same message to more than one mailbox must be done in single operations.*

Access the mailbox.

(See chapter "[Access the Mailbox](#)" on page 57.)

Listen and follow the voice announcements in the main menu.

3

Select to record and send messages.

Listen and follow the dedicated voice announcements.

Messages can be heard or re-recorded before they are sent to a mailbox.

Note: *A message can also be sent during a call, see "[Send Message](#)" on page 40.*

Outcall (External) Notification

Note: *This function is not applicable for the common mailbox*

With this function, the mailbox system can notify you when new voice messages arrive. You can specify an external number where you will be called at a pre-programmed time or as soon as a new message arrives.

Note: *This feature may be restricted or not available. Ask the system administrator for the availability and more information.*

You can be notified in two different ways (depending on the programming of the system):

- Notification with mailbox access:
You acknowledge the notification via your password (has to differ from the default value 0000). See section “[Change Password](#)” on page 62 to select a new password. You have full access to the mailbox system.
- Notification without mailbox access:
You get a short voice announcement informing you that someone has left a message for you. You acknowledge the notification by pressing any key. You have to call back the mailbox system to retrieve the message.

Note: *If you do not acknowledge the notification within the pre-programmed time, the connection is cancelled and repeated later (ask the system administrator for the programmed number of notification attempts).*

Access the mailbox.

(See chapter “[Access the Mailbox](#)” on page 57.)

Listen and follow the voice announcements in the main menu.

4

Select to set up outcall notification.

Listen and follow the dedicated voice announcements.

You can program the external notification number, the notification time and activate/deactivate the function. The external number (including the digit(s) for external line access) can consist of up to 24 digits. The time is entered in 24h-format, e.g. 2030 for half past eight with values automatically set to even quarters, i.e. 2013 will be 2015.

Note: *The notification number and time must be programmed before you activate the notification.*



Press to finish the procedure.

Change Password

Change the password via your individual mailbox

Note: This function is not applicable for the common mailbox

Access the mailbox.

(See chapter “[Access the Mailbox](#)” on page 57.)

Listen and follow the voice announcements in the main menu.



Select to change the password.

Listen and follow the dedicated voice announcements.

Press to finish the procedure.

Change the password via the telephone

* 7 2 *

Dial to select a new password.



Dial your present password.

The default password is 0000.



Press.



Dial your new password.



Press.

Verification tone.



Press to finish the procedure.

Dictaphone Function

If you want to record and retrieve personal voice messages you, can use the Dictaphone function. A Dictaphone message is treated as a normal message. For information on how to retrieve Dictaphone messages, see section "[Listen to Messages](#)" on page 58.

Record message

To start the recording:



*** 5 8 #**

Lift the handset.

Dial and record your message.

The maximum recording time is 4 minutes and 15 seconds.

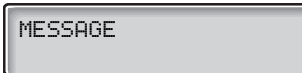

Select one of the following options:

Press to play-back.

9

Press and speak to re-record.

#

Press to stop the recording and save the message.



Press to finish the procedure.

Conversation Recording

The Conversation Recording function makes it possible to store the ongoing telephone conversation in the Individual Mailbox by pressing a pre-programmed Recording key. You can store both internal and external calls. Conference calls cannot be stored.

A recorded conversation is treated as a normal Voice message. How to retrieve conversation recordings, see section “[Listen to Messages](#)” on page 58.

Note: *This feature may be restricted or not available. Ask the system administrator for the availability and for more information. Furthermore, a Conference tone can be audible during the entire recording session.*

To start or stop recording the ongoing call:

Recording 

Press the Recording key (pre-programmed).

While recording is active a steady light indicates that the conversation is being recorded. You can start or stop the recording whenever you want. The maximum recording time is 4 minutes and 15 seconds, if you want to record for a longer period, just repeat the procedure.

Warning! *Recording a conversation without prior notice to the other party may be illegal. Forwarding or playback of this recorded conversation to a third party without prior permission may be illegal.*

It is obligatory for the recording initiator, to ask the other party in advance for permission and to inform the same of the purpose and further usage of this particular recording. The adherence to the relevant legislation is the exclusive responsibility of the user, offences can be criminally prosecuted. Neither the manufacturer nor the dealer of this product is responsible for the abuse of this feature by the user or for any damages caused thereby.

System Phonebook

The System Phonebook covers internal directory numbers as well as external common abbreviated numbers.

Use the System Phonebook

***0#**

Press to search for internal directory numbers

Or:

#0*

Press to search for common abbreviated numbers

The display shows:

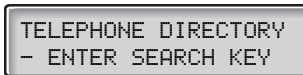

```
TELEPHONE DIRECTORY
- ENTER SEARCH KEY
```



To exit the System Phonebook

Press to exit

Make a Call



Enter the first letter(s) of the name.

When pressing a key, the first available character on that specific key is displayed. To get the following characters, press the key repeatedly. Key 0 and 1 contain special characters. The marked character is selected after a time-out (3 seconds) or when another key is pressed.

Note: *In order to step through the whole System Phonebook, you can start the search function immediately without entering the first letter(s) of the name.*

Press to activate the search function

Search routine was succesful

The first entry which matches with your entered letter(s) will be displayed.

0 Press to scroll forward in the list

Or:

* Press to scroll backward in the list

By reaching the beginning or the end of the list a short beep tone will be sent.

Line 1 

Press to call the desired list entry

Search routine was not succesful

If no entry fulfils the search criteria, the display shows:

```

SORRY-NO SUCH NAME
return:1

```

1 Press to start a new search

Security

Block extension

You can block your extension in order to prevent unauthorized external calls. You can still make internal calls and you can also receive incoming calls.

***72#**



Press to block your extension.
Verification tone.

Press to finish the procedure.

Un-block extension

#72*



Press.

Enter your Password.

Note: To change your password see chapter "[Change Password](#)" on page 62

#



Press to re-open.

Verification tone. Your extension is open for use.

Press to finish the procedure.

Bypass blocked extension

In order to make a call, you can temporarily bypass a blocked extension by using your personal password.

Note: To change your password see chapter "[Change Password](#)" on page 62

Bypass own extension

*** 7 2 ***

Press.

⊙ ⊙ ⊙
⊙ ⊙ ⊙
⊙ ⊙ ⊙
⊙

Enter your Password.

#

Press.

Dial tone. You can make one call from your extension.

Bypass another extension

This makes it possible to make a call on another, blocked extension, by using your Password.

*** 7 2 ***

Press.

⊙ ⊙ ⊙
⊙ ⊙ ⊙
⊙ ⊙ ⊙
⊙

Enter your Password.

Press.

⊙ ⊙ ⊙
⊙ ⊙ ⊙
⊙ ⊙ ⊙
⊙

Enter your extension number.

#

Press.

Dial tone. You can make one call from the blocked extension.

Group Features

When you are working together in a team the following Group features can be very useful. You can page your colleagues, give them Key system or pick-up their incoming calls.

Key system

With this function, all (or selected) external lines are represented by pre-programmed keys on all phones. For each external line, a Function key has to be programmed. Which means that you are able to monitor the state of traffic for every programmed external line (e.g. free, busy). You can also establish an external call by pressing the External Line key.

Answer an external call

To answer an external call, just press the flashing key. (Depending on the programming of the system, an incoming external call will be announced with a flashing Line key and a ringing signal.)

External Line



Press (pre-programmed).

Speech connection with the caller.

Make an external call

To initiate an external call, just press the External Line key. The external line will be seized automatically.

External Line



Press a free Line key (pre-programmed).



Enter the desired number.

If you make external calls in this way, you do not have to dial the digit(s) for external call access first.

Supervision/Telephone Attendance

A Function key can also be programmed for Supervision and handling calls for a group of extensions. If a Supervision/Attendance key is programmed on your telephone, you are able to call the other group members or answer incoming calls for the group by pressing the key and monitor the activity of other extensions (free, busy, called).

Traffic situation



Ongoing conversation (lamp is on).



Free extension (lamp is off).



The extension is called (flashing lamp).

Pick-up calls for the group

Your colleague's extension is indicated on your phone by a pre-programmed key.



Press to answer the calls directly (pre-programmed).

A flashing lamp beside the key indicates an incoming call.

Call a group-member



Press to make a call (pre-programmed).

Note: *If the key is flashing, you will automatically pick-up your colleague's ongoing call.*

Group Call-pick-up

In a Pick-up group, any member can answer any individual call to group members. You answer a call to the group by dialling a special answering number. Please ask your system administrator for the configured number.



Enter the Group Call-pick-up code.

Loudspeaker Paging

You can page all extensions in a group and give a Voice message.



Press (pre-programmed).

All extensions in a group are called.



Press again and hold the key (pre-programmed).

Give the Voice message and then release the key. Now you can wait for answer, or terminate. If you do not get an answer within 30 seconds, the Paging function will be terminated automatically.

Answer Paging

A short signal and a flashing Paging key will inform you when a Loudspeaker Paging is received.



Press (pre-programmed).

An internal call is established with the paging party.

Common Bell

The Common Bell facility allows all extensions of the system (operator included) to pick-up the call from an extension that has been predefined as a Common Bell extension.



Enter the Common Bell pick-up code.

Please ask your system administrator for the Common Bell pick-up code.

You will immediately be connected to the calling party. If two or more extensions simultaneously attempt to answer a call from the Common Bell extension, only the first extension will pick it up. The other extensions will receive the number unobtainable tone and their displays will show the message `No call waiting at common bell`. This will also happen if you dial the Common Bell pick-up code and there are no calls waiting at the Common Bell extension.

Note: *You can also program the Common Bell code on a Function key.*

Group Hunting

Your telephone can be included in one or several hunt groups. In a hunt group all members are represented with one common directory number. 16 hunt groups can be programmed, each containing 1 to 20 members. A member can be either an extension number, an operator console or a fictive number. Please ask your system administrator if you require this function.

Note: *The number of cordless extensions in a hunt group are limited to eight (including Tandem configurations).*

Incoming calls to the hunt group are directed to free extensions in the group. The hunt order within the group can be changed to suit your needs. If all members of the hunt group are busy, an incoming call is being queued. If no one answers this call before the programmed time, the call is forwarded to the programmed answering position (e.g. operator).

Note: *If all members in a hunt group are busy, the Callback or Intrusion function is not available.*

Log in

Before you can answer Group Hunting calls, you must log in.

To log into one hunt group:

*** 2 8 ***

Press.

⊙ ⊙ ⊙
⊙ ⊙ ⊙
⊙ ⊙ ⊙
⊙

Enter the hunt group code.

Please ask your system administrator for the configured number.

#

Press.

To log into all hunt groups:

*** 2 8 * * #**

Press.

Answer calls

As system default the hunt group number is shown in the display. If you require a different display layout, please contact your system administrator.



Answer Group Hunting calls in the normal way.

Log out

To log out from one hunt group:

2 8 *

Press.



Enter the hunt group code.

Please ask your system administrator for the configured number.

#

Press.

Note: *If you are logged into more than one hunt group and log out from one of them, the display will show the following text:*

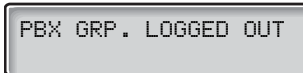

To log out from all hunt groups:

2 8 * *

Press.

ISDN Facilities

Note: *This section only applies to the Dialog 4222 Office and the Dialog 3212 Standard telephone.*

This chapter is only relevant when your system is connected to a digital trunk line (ISDN-trunk line). It provides a general view of all the (supplementary) services available from the public net which are supported by the system. The services from the public net differ from market to market. Please ask your system administrator which features are available.

Number Identification

The main difference compared to the analog public net is the Number Identification between the connected parties.

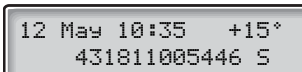

```
12 May 10:35  +15°
431811005446 S
```

When you establish an outgoing external call, the public number of your system and your extension number will be sent to the called party. If the number of the answering party is different from the dialled one (for example, after a diversion), you will also be informed about the answering party's number.

When you answer an incoming external call on your phone (or from another phone), you will see the caller's number on the display. Your public number will be sent to the caller.

If a name is available to the external caller's number in your system, it is shown alternating to the number. (Please contact your system administrator whether the feature name presentation is available in your system)

Answer an incoming call from an ISDN-line

A ringing signal and a flashing lamp indicate an incoming call, answer the call in the normal way. One of the following four cases will occur.

Example 1:

The public net provides the number of the caller.

Mr. Plattner with public number 0 181100 4736 is calling.

```
12 May 10:35 +15°  
1811004736 C
```

Example 2:

The caller has activated Number Secrecy. (The calling number will be suppressed.)

```
12 May 10:35 +15°  
DISPLAY REST C
```

Example 3:

The public net cannot provide the calling number, in this case the normal number of the external line will be shown.

```
12 May 10:35 +15°  
EXTERNAL 701 C
```

Example 4:

The calling number has been diverted in the public net, the calling and the diverting number will be shown.

```
43181188  
1811004736 C
```

Make an external call on an ISDN-line

Establish an external call in the normal way.

If the called party is also connected to a digital trunk line, your public number is shown on the called party's display.

If the connected party number differs from the dialled one (for example: Diversion or Pick-up from another extension), your display shows the new number.

Example:

Called Party number 0 181100 Extension 4736

```
12 May 10:35 +15°
01811004736 F
```

The desired extension 4736 will be answered by extension 5446.

```
12 May 10:35 +15°
01811005446 S
```

When the connected party has activated Number Secrecy (number suppression), your display shows the following information.

```
12 May 10:35 +15°
DISPLAY REST S
```

Malicious Call Identification

If you are disturbed by malicious external incoming calls, you can request a number tracing from the network provider.

If you cannot see the number of the caller or connected party (because of an activated number suppression), you have the possibility to register the number in the public network during the call.

Malicious Call ID.



Press to register the connected number (pre-programmed).

Or:

***39#**

Press to register the connected number.

If the function is accepted in the public net, your display shows the following information.

```
MCID ACCEPTED
DISPLAY REST  S
```

If you cannot identify the connected party, your display shows the following information.

```
MCID REJECTED
DISPLAY REST  S
```

After 3 seconds the display will revert to the previous state.

Number Secrecy

By pressing a pre-programmed Number Secrecy key you can choose not to show your complete number (public + extension number) to the connected party.



```
12 May 10:35 +15°
DISPLAY REST S
```

Number Secrecy



Press a pre-programmed key to suppress your complete number to the public net.

The lamp beside the key shows a steady light and the function remains activated until the key is pressed again.

Other Useful Features

By using these features your productivity will be increased, e.g. you can set reminders for important meetings, place the cost for external calls on separate accounts, listen to music via the loudspeaker and much more ...

Tandem configuration

The Tandem configuration is a unit, consisting of two telephones using the same directory number. One of the telephones is defined as the Primary and the other one as the Secondary. This function enhances the communication for users that, for example, have a wired phone on their desk (the primary telephone) and need to be mobile within their company's building with their own portable (the secondary telephone). Basically the Tandem configuration works as follows:

To activate the Tandem configuration

Secondary on/off



Press (pre-programmed).

Or:

*** 2 8 #**

Press to log on the secondary telephone.

```
12 May 10:35 +15°
2nd USER LOGGED ON
```

For incoming calls:

- Both telephones are treated as 1 single extension.

For outgoing calls:

- Both telephones are treated as 2 separate extensions.

Secondary on/off



2 8

To deactivate the Tandem configuration

Press (pre-programmed).

Or:

Press to log off the secondary telephone.

For incoming calls:

- The secondary telephone cannot be called and the primary telephone works as a normal stand-alone telephone.

For outgoing calls:

- Both telephones are treated as 2 separate extensions.

Inquiry



Transfer



Transferring a call between members of a Tandem unit

Press and dial own directory number.

Press.

Reminder

The phone can be set to remind you at any time within the next 24 hours (multiple settings are allowed).

*** 3 2 ***



Press.

Enter reminder time and press.

(00-23) hour + (00-59) minute. Example: 1430.

REMINDER TIME 1430

Note: If you receive busy tone, your extension does not have the authority to set a reminder.

In case of a typing error, press the Volume Down key to delete the latest entered digit.



Press to finish programming.

When the reminder time is reached, your phone rings with recall signal.

3 2



Cancel reminder

Press to cancel all settings.

Press to finish the procedure.

Background Music



Background Music

You can listen to Background Music over the loudspeaker on your phone by pressing a pre-programmed Music key, or by entering the number for the music channel. Please ask your system administrator for the configured number.

Press to activate the music (pre-programmed).

The music automatically switches off when you make or receive calls and switches on again when the call is finished.

Press to cancel the music.

Note: You can adjust the volume, see section "Settings" on page 88.

Doorphone

The Doorphone is used to monitor the admission to your company, i.e. you can open the doorlock from your phone.

Answering Doorphone calls

Line

Press the flashing Line key.

You will be in speech connection with the calling party.

Opening of the doorlock

After you have answered the Doorphone, you can open the door making an inquiry to the door-opener's directory number.

Inquiry**Press.****Enter the door-opener's directory number.**

Please ask your system administrator for the number.

Note: You can also program the door-opener's directory number as a Common Abbreviated Number or a function key.

Intercom Line

A two-way direct call function between two extensions, for instance in executive-secretary communication.

Intercom
secretary**Press to establish an Intercom call (pre-programmed).****Press to cancel the Intercom call.**

Night Switching

If you want this facility, please ask your system administrator. This function is used for directing all incoming calls to one extension (answering position), e.g. when the office is closed.

Night

**Press to activate or deactivate (pre-programmed).**

When the lamp lights, Night Switch is active. When the lights extinguishes, Night Switch is passive.

Direct Inward System Access (DISA)

If you are working externally and you have the need to make business calls, call your company and use the company PBX to make an external call to the desired party. You just pay the cost for the phone call to your company. The other cost will automatically be placed on your extension number or on a special project.

Note: To activate this function, you have to change the Default Password from 0000 to a personal one. Which code to use and how to change it, see section [“Change Password” on page 62](#).

You can also divert calls from your office extension to your external position, see section [“Call Forwarding” on page 45](#). During the procedure you will be prompted for your Password.



Enter the public number of your company,



followed by the DISA number.

Ask the system administrator for the defined DISA number.

Note: If want to register the call on an Account Number, you should use the Account Number procedure before you enter the external number, see section [“Account Number” on page 84](#).

Follow the voice announcements

0



Dial the digit(s) for external line access and the desired public number.

Note: Which digit to press for external line access depends on the configuration of the system.

Or:

Use the External Diversion function.

Procedure, see section [“Call Forwarding” on page 45](#).

Note: If you program a new diversion address, remember to reset it when you return to your office.

Account Number

An Account Number can be entered to debit telephone cost to different accounts. Depending on the system configuration the Account Number has to be entered from a Verified Account Number List (predefined) or you can invent your own Account Number. The following prerequisites apply:

- With the Verified Account Number you can restrict the making of external calls (not a specific number or area), so everyone who is allowed to make external calls will receive an Account Number which has to be used each time he/she wants to make an external call.
- Verified Account Numbers contain up to 10 digits and can only be used *before* you make a call (outgoing external calls).
- Own Account Numbers contain up to 15 digits and can be used *before* or *during* the call (outgoing external calls).

The Account Numbers can also be used via the DISA function, see section "[Direct Inward System Access \(DISA\)](#)" on page 83.

Verified or own Account Number

✖ 9 ✖

Press.

This code cannot be entered during the call.

Or:



Press (pre-programmed).

Account
Number



Enter Account Number and press.

Valid digits 0-9.

DTMF Tones

The DTMF function is used to control answering machines or any other telecommunication devices.

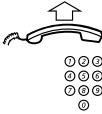

Lift the handset.

Make an internal or external call to reach the desired device.

When your call is answered you can continue to dial digits which will be sent as DTMF digits (tone signals) to the called device in order to activate the desired functions.

Immediate Answer

It is possible to get automatic hands-free answering on internal calls without pressing the Line key. If you require this facility, please ask your system administrator.

Immediate
Answer



Press the Immediate Answer key (pre-programmed).

Incoming calls will be indicated by one muted ringing signal, the On/Off lamp lights and the call comes straight in through the loudspeaker.

Note: To accept a transferred external call you must first press the Transfer key.

Cancel Immediate Answer

Immediate
Answer



Press the Immediate Answer key (pre-programmed).

The lamp extinguishes.

Networking

Networking is the connection of several premises within a company. The connection can be set up via leased lines, public lines, Local Area Network (LAN) or Wide Area Network (WAN). Ask your system administrator about details regarding networking.

IP Calls

IP Calls are internal calls sent via an internal data network (LAN or WAN) and the transfer of data and voice is made on the same line. If you are connected to an internal data network the IP connection is made automatically. To minimise the traffic on the network the speech quality is decreased.

If the speech quality is not acceptable you can disconnect the IP call and switch to a non-IP call (alternative network). The switch from the IP net to the non-IP net is made during the call, so the call does not have to be disconnected.

If you want to switch to a non-IP net during the call:

Inquiry 
*** 6 1 ***

Press.

Press.

During the procedure the other party is put on hold. When the procedure is ready you will receive a special ringing tone and the call is resumed in the non-IP net.

```
12 May 10:35 +15°
SPEECH PATH REPLACE
```

Note: A switch to a non-IP call can only be performed if the original call is an IP call, otherwise you will receive a Blocking tone.

Least Cost Routing

Least Cost Routing (LCR) automatically selects the cheapest way to establish the connection to the desired external number. Please ask your system administrator if this function is installed in your system.

If the extension has been configured to use LCR, each external call will be analysed and the cheapest routing will be selected.

Use Least Cost Routing

0 

Enter the digit(s) for external line access and the desired public number.

The usual way of making an outgoing external call.

Note: Which digit to press for external line access depends on the configuration of the system.

Calling Least Cost Routing

If LCR has been installed in your system, but your extension is not configured to use it automatically, you also have the opportunity to get the cheapest connection by dialling the LCR code before you dial an external number.



Enter the LCR code.

Please ask your system administrator for the LCR code.

0 

Enter the digit(s) for external line access and the desired public number.

Note: Which digit to press for external line access depends on the configuration of the system.

Note: You can also program the LCR code on a Function key.

Settings

If you require frequent use of certain functions, you may program them on the Dual-Function keys on the telephone. When you want to use the function, just press the key.

Note: *The Dual-Function keys allow programmed functions and short numbers to be combined on the same keys. Remove the transparent cover in order to write the name beside the key. Put the name referring to the programmed function in the field above the line to indicate that it is the primary function. If a function is already programmed on the key, this will be displayed when you start programming.*

Programming of Dial-by-Name keys and Individual Abbreviated Numbers are described in section "Abbreviated Numbers" on page 28 and how to program a new diversion address is described in section "Call Forwarding" on page 45.

Program a function

How to program a function on key A.

Note: Some functions can also be programmed as Individual Abbreviated Numbers, see section "Abbreviated Numbers" on page 28.

00



Press to enter the programming mode.



Press the desired programmable key.

Enter the function code.

See section "Function codes and required data" on page 91.



Press the programmable key again.



Enter associated number.

See section "Function codes and required data" on page 91.



Press the programmable key again.

Continue with section Select ringing character.

Or:



Press to finish programming.

After approximately 10 seconds, the Function key is active

Select ringing character



Enter ringing character (0-4).

See section "Function codes and required data" on page 91.



Press the programmable key again.







Press to finish programming.

After approximately 10 seconds, the Function key is active.

Example:

Program Supervision of extension 204 on key A, with ringing character 1. For available Function codes, see section "Function codes and required data" on page 91.

- *00*** Press to enter the programming mode.
- A  Press the desired programmable key.
- 13** Enter the Function code for Supervision.
- A  Press the programmable key again.
- 204** Enter extension number.
- A  Press the programmable key again.
- 1** Press to select ringing character.
- A  Press the programmable key again.
-  Press to finish programming.

Function codes and required data

Programming name	Function name	Function code	Associated number	Ringing character
NAMECALL	Dial-by-Name	10	Extension number	—
SUFFIX DIGIT	Camp-on	11	4	—
	Automatic Callback	11	5	—
	Answer calls, another extension	11	6	—
	Radio Paging	11	7	—
	Intrusion	11	8	—
EXTERNAL LINE SUPERVISION	External Line	12	Directory number of line	0 – 4
	Supervision/Tel. Attendance	13	Extension number	0 – 4
DEDIC. LINE	Intercom	14	Extension number	0 – 4
BUSY LINE 2	Free On 2nd Access	26	—	—
CONFERENCE	Conference	27	—	—
IMMED. ANSWER	Immediate Answer	28	—	—
EXT. VOICE M.	External Voice Mail	34	—	—
HOLD	Hold	35	—	—
TRANSFER	Transfer	36	—	—
SAVE	Save/Redial	37	—	—
READ &	Read &	38	—	—
NUMB SECRECY	Number Secrecy	40	—	—
ARD REQUEST	Automatic Redial	46	—	—
ARD PAUSE	Pause Automatic Redial	47	—	—

Note: Accessible functions depend on the programming of the system; if you require another function please contact your system administrator. The functions above are the default functions.

Ringing character:

0 = No ringing.

1 = Ringing.

2 = Delayed ringing (after 10 seconds).

3 = One single ringing signal (muted signal).

4 = One delayed ringing signal (after 10 seconds. Muted signal).

Alternative programming for Automatic Callback, Camp-on, Intrusion

The associated number for using the Automatic Callback, Camp-on or the Intrusion function may vary from country to country. If you cannot use a code of a function, maybe your exchange system has been programmed with a different associated number.

Because this User Guide describes only the default programming, the following table shows the most common settings in some of these countries that are known for a different programming.

	<i>Austria, Belgium, Brazil, Denmark, Germany</i>
<i>Camp-on</i>	5
<i>Automatic Callback</i>	6
<i>Answer calls, another extension</i>	8
<i>Intrusion</i>	4

Handset and loudspeaker volume

Use the volume keys. You can set different volume levels for internal and external calls and for Background Music. During a call, adjust handset listening volume in handset mode. Adjust loudspeaker volume in Monitor mode or during Background Music.



Press to change the volume.



For people with impaired hearing, the handset hearing volume level can be extra amplified. To change the level:

Press and hold simultaneously until a ring signal is heard.

The display shows:

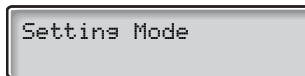

The Line 1 key lamp indicates the setting of the option unit:

- ON = amplified volume level.
- OFF = default volume.



Press to change to amplified volume level,

Or:



Press to change to default volume,

#

Press to save setting and exit.

Note: A level change also effects a headset connected to the headset outlet.

Ringling signal

By programming, you can adjust ringing type (2 types), ringing volume (10 steps) and ringing character (10 characters).

✳ 0 0 ✳

Press to enter the programming mode.

You can now select ringing type, volume or character.

Ringling type

Select type 1 if you want to set the ringing volume at a constant level, select type 2 if you want gradually increasing volume when the phone rings.

1 ✳ 1

Press.

Or:

1 ✳ 2

Press.

You will hear the selected type.



Press to finish the procedure.

Note: When type 2 is selected, the programming of the ringing volume is not applicable.

2 * 0 - 9



Ringling volume

Press.

You will hear the selected volume (0...lowest volume, 9...highest). You only have to press the last digit to select another ringling volume.

Press to finish the procedure.

Note: *This programming is not applicable when you have selected ringling type 2.*

3 * 0 - 9



Ringling character

Press.

You will hear the selected character. You only have to press the last digit to select another ringling character.

Press to finish the procedure.

Melody programming

If you want a personal melody when your telephone rings, this can be programmed for internal, external or Callback calls.

Note: *For the Dialog 3212 Standard this function requires the release number R7B or higher; for the Dialog 3211 Economyplus this function requires the release number R6B or higher, see the underside of your telephone. If you can enter Melody Mode your telephone supports this function.*



Melody Mode





Press and hold to enter Melody Mode.

Enter Programming mode to program a melody.

Or:

#

Press to exit Melody Mode.

- 2nd**  **Programming mode**
Press to enter Programming mode.
- Line 1**  **Select the call type you want to program.**
- Line 2**  **Press for internal calls.**
- Or:**
- Inquiry**  **Press for external calls.**
- Or:**
- Press for Callback calls.**
- Select Programming mode options to control the melody.**

Programming mode options

Insert notes:



Enter to insert notes.

1=c, 2=d, 3=e, 4=f, 5=g, 6=a, 7=b, 8+=c, 9=+d

Note: *Press and hold a key to make a long tone (shown with a capital letter e.g. D).*

Change the pitch steps:

#

Press to change.

Press once for sharp pitch, twice for flat pitch and three times to get the normal pitch.

Insert a pause:

Press to insert a short pause.

Hold the key to get a long pause.

Change the octave:

0

Press to get a higher or lower octave for the note you have inserted.

It is higher when a plus sign is added beside the note.



Scroll within the melody:

Press to move the cursor within the melody.
Hold the key to move to the beginning or the end.



Erase note or melody:

Press to erase the note to the left of the cursor.
Press and hold to erase the whole melody.

Store the melody:



Press the flashing Line key.



Press to exit program mode.
You enter Melody Mode.



Press to activate/deactivate the programmed melody for internal calls .

Or:



Press to activate/deactivate the programmed melody for external calls.

Or:



Press to activate/deactivate the programmed melody for Callback calls.



Press to exit Melody Mode.

Display contrast

You can adjust the contrast for the display.



Press and hold simultaneously until a ring signal is heard.

The display shows:



Press.

The display shows:



Press repeatedly to adjust the contrast.



Press to save and exit.

Note: To exit the menu without saving the changes, press # before you press any of the adjustment keys.

Accessories

This chapter describes optional features that can be used together with your BusinessPhone telephone.

Expansion key panel

Note: Only available for Dialog 4222 Office.

Each key panel offers 17 additional keys for storing of your most frequently used telephone numbers and functions, and for supervising extensions. Your telephone can be expanded with one key panel.

Note: One key panel of type DBY 419 01 can be connected to the Dialog 4222.

Option unit

Dialog 4222 Office

The Option unit DBY 420 01/1 is an optional accessory, to be installed on the bottom of your telephone set. The following devices can be installed via the Option unit:

- Extra bell or busy indication outside your door

To check or set the option unit for extra bell or for busy signal:

Press and hold simultaneously until a ring signal is heard.

The display shows:

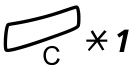

OPTION PROGRAMMING

The Line 2 key lamp indicates the setting of the option unit:

- Off=Extra bell
- On=Busy signal lamp
- Flashing=Combined extra bell & busy lamp.

Line 2 

Press to change to busy signal,

Or:

Line 2 

Press to change to extra bell & busy signal,

Or:

Line 2 

Press to change to extra bell.

#

Press to save the setting and exit.

***Note:** If you do not press #, the phone automatically returns to idle about 30 seconds after the last key press.*

Dialog 3211 / Dialog 3212

The Option unit DBY 410 02 is an optional accessory, to be installed on the bottom of your telephone set. The following devices can be installed via the Option unit:

- Tape recorder
- Extra bell or busy indication outside your door
- Enhanced Headset functionality
- PC Sound Card
- Second handset

***Note:** For people with impaired hearing the Option unit offers the possibility to amplify the receiving volume in the handset and headset.*

Extra handset

Useful for involving a second person in your conversation, for talking or just listening.

Tape recorder

When a recording of the telephone conversation is needed, for evidence purposes, a tape recorder can be connected.

Headset - Dialog 4222 Office

Note: *Optional accessory for 4222 Office.*

How to install the headset, see section "Installation" on page 106. The following headset functions are available.



Activate/Deactivate the headset

Press the Headset key to activate/deactivate.

See section "Description" on page 7. All calls can be handled via the headset.

Line 1



Answer calls

Press the flashing Line key to answer.



Press to terminate a Headset call.

Make calls

Enter the desired number.



Press to terminate the call.



Headset to handset

Lift the handset.



Handset to headset

Press the Headset key.



Headset with Group Listening

Press to toggle between headset with or without Group Listening.



Headset to handsfree

Press.



Press the Headset key.



Handsfree to headset

Press the Headset key.

Headset - Dialog 3211 & Dialog 3212

The following Headset functions are available.

Note: To use the Headset functions your telephone has to be equipped with option unit DBY 410 02. How to install the option unit, see separate installation instructions provided with the option unit.

Activate/Deactivate the headset



Press the Headset key to activate/deactivate (optional).
See section "[Description](#)" on page 7. All calls can be handled via the headset.

Answer calls

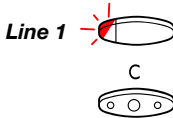

Press the flashing Line key to answer.

Press to terminate a Headset call.

Make calls

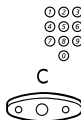

Enter the desired number.

Press to terminate the call.

Headset to handset



Lift the handset.

Handset to headset



Press the Headset key (optional).



Headset with Group Listening

Press to toggle between headset with or without Group Listening.



Headset to handsfree

Press.



Press the Headset key (optional).



Handsfree to headset

Press the Headset key (optional).

Useful Hints

Connections between external lines

With your BusinessPhone PBX, you can establish an external call diversion or a conference with more than one external party or transfer an external call to another external destination (e.g. a mobile phone). These features are very useful for everyday business life.

Note: *When these features are used, your BusinessPhone will occupy at least two external lines.*

However, there may be disadvantages in connecting to several external lines. We would therefore like to draw your attention to the following:

- **Please do not transfer external calls to an external Mailbox, to information systems or to external parties before they have answered.**
- **Cancel your calls by pressing the Clear key.**

If the external parties are not persons (Mailbox, automated information or attendant systems, etc.), connections on external lines can last a long time, which can be costly. Moreover, such calls may occupy two of your system's external lines. You can restrict connections between the external lines by re-programming your system.

Please ask your system administrator or contact our service center for more information.

Installation

Dialog 4222 Office

Install cables

Handset cable to the left

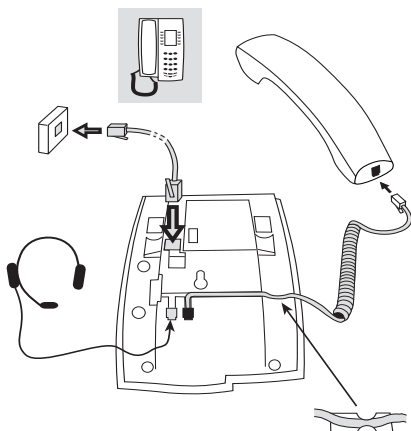

Handset cable to the right

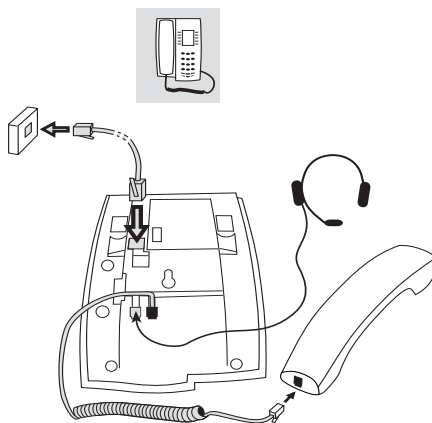

You can put the cable to the handset in the notch underneath the telephone. The cable to the exchange has to be plugged in LINE and the handset cable has to be plugged in HANDSET.

Change cables

Use a screwdriver to unlock the stop.

Install stands and adapt telephone

Position high

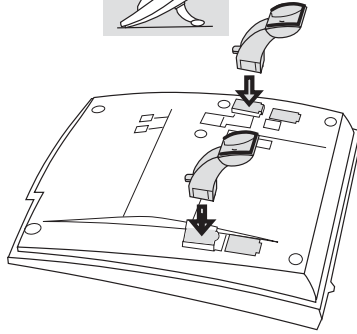

Position low

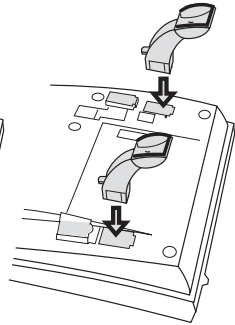

Press to fasten stand

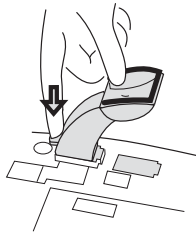

Release to remove stand

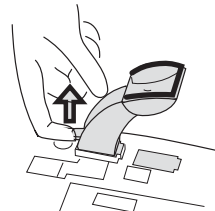

Install key panel

Note: Only available for Dialog 4222 Office.

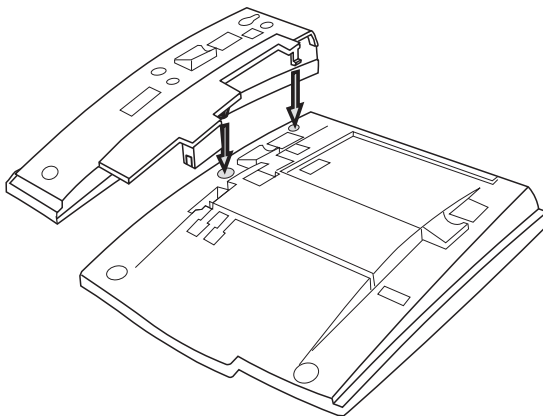

- 1 Remove the small plastic plate, marked DSS, i.e. with a screwdriver and connect the cable.**
- 2 Attach the key panel unit.**
- 3 Secure with screws and install stand.**

Note: The key panel must be of type DBY 419 01, and it can only be used with newer exchange versions.

Stand positioning

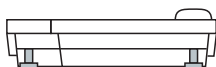

Install card

Use the Designation Card Manager to make and print your own key panel designation cards. The Designation Card Manager is included on the Enterprise Telephone Toolbox CD. For questions regarding the product, please contact your Aastra Certified Sales Partner.

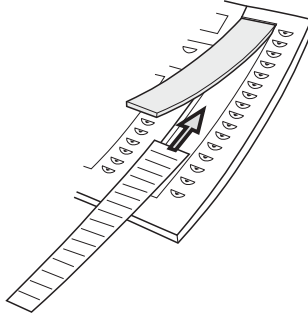

Install pullout leaf

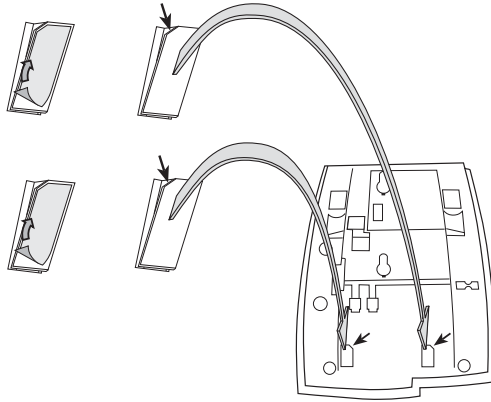

- 1 Remove the protective film from the guiding rails.**
- 2 Attach the guiding rails to the bottom of the phone, observing the direction of the “cut” corner.**

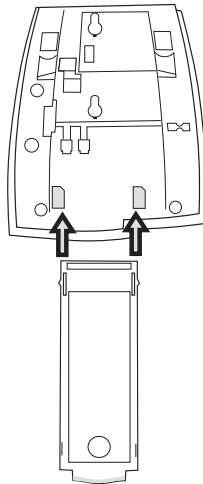

- 3 Insert the pullout leaf.**

Wall mounting handset hook

The phone can be wall mounted without using a special console. Useful for instance in conference rooms or public areas.

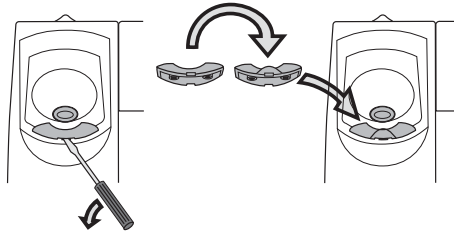

- 1 Use a screwdriver to remove the handset hook.**
- 2 Turn the hook upside down and insert.**

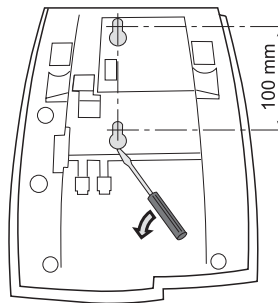

- 3 Use a screwdriver to remove the two plastic covers.**
- 4 Drill wall holes according to measure.**

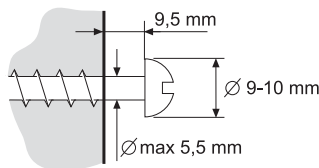

- 5 Mount screws according to measures and attach the phone.**

Install card

Use the Designation Card Manager to make and print your own designation cards. The Designation Card Manager is included on the Enterprise Telephone Toolbox CD. For questions regarding the product, please contact your Aastra Certified Sales Partner.

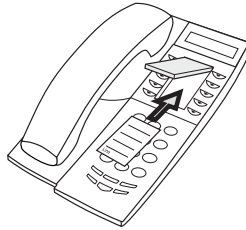

Placing the phone

- Do not place your telephone on sensitive surfaces. Use a non-slippery pad to protect your furniture from possible damage.
- Do not place your telephone near sources of extreme heat, e.g. near the radiator.
- Make sure that the line cable isn't creased.

Cleaning the telephone

Use a slightly moistened (not wet) soft cloth or an anti-static cloth and wipe off the telephone carefully. Do not use rough cloth, solvents or aggressive cleaning fluids. Any damages of the telephone, that are caused by non-observance of these instructions, are not part of the liability given by the manufacturer.

Dialog 3212 Standard / Dialog 3211 Economyplus

Install cables

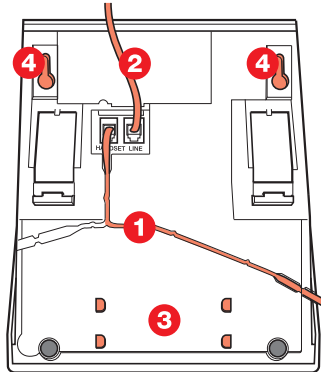

- 1 Cable to handset
- 2 Cable to exchange
- 3 Space for personal directory list (optional)
- 4 Wall mounting screw holes

You can put the cable to the handset in any of the two notches underneath the telephone. The cable to the exchange has to be plugged in LINE.

Change cables

To remove a cable, push down the plug stop. Use a screwdriver to unlock the stop.

Wall mounting handset hook

When mounting on a wall, you have to pull out and turn the hook.

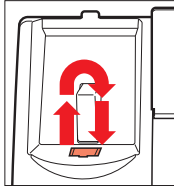

Install stand and adjust telephone

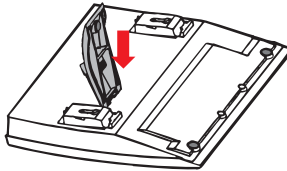

Press to decrease angle

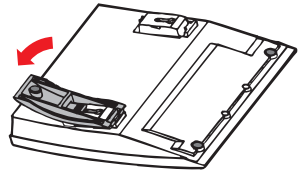

Pull to increase angle

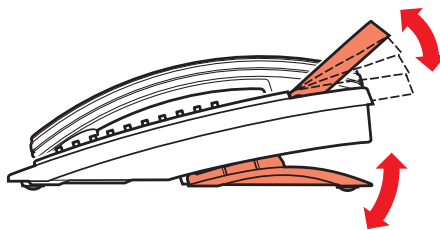
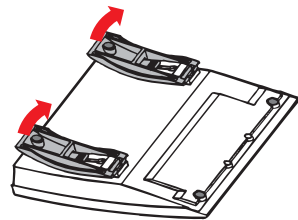
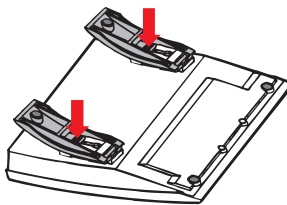

Tiltable display
(Standard only)

Adjustable angle

Placing the telephone

- Do not place your telephone on sensitive surfaces. Use a non-slippery pad to protect your furniture from possible damage.
 - Do not place your telephone near sources of extreme heat, e.g. near the radiator.
 - Make sure that the line cable isn't creased.
-

Cleaning the telephone

Use a slightly moistened (not wet) soft cloth or an anti-static cloth and wipe off the telephone carefully. Do not use rough cloth, solvents or aggressive cleaning fluids. Any damages of the telephone, that are caused by non-observance of these instructions, are not part of the liability given by the manufacturer.

Glossary

Abbreviated Number Dialling

Initiating a call to a pre-programmed number by dialling a code or pressing a key. Short numbers can be:

1. *Common, which means that all extensions can use them.*
2. *Individual, which means that they are programmed and used by each extension separately (14 numbers).*

See section "[Abbreviated Numbers](#)" on page 27.

Account Number

To place call cost on an Account Number. See section "[Other Useful Features](#)" on page 78.

Automated Attendant

A facility which sends voice instructions to internal and external callers, providing all options which can be chosen. Voice instructions lead the caller to the desired destination. See section "[Other Useful Features](#)" on page 78.

Callback

An indication to a busy extension, to inform the person that you want to speak to him/her. See sections "[Outgoing Calls](#)" on page 22.

Camp-on

To place (queue) a call to a busy extension. See section "[Outgoing Calls](#)" on page 22.

Counter

The counter keeps track of the time and cost of your calls. See section "[Call Metering](#)" on page 42.

Dial-by-Name

Initiation of a call by operating a single key. Internal numbers (or Common Abbreviated Numbers) can be stored on each extension. See section "[Abbreviated Numbers](#)" on page 27.

Direct Inward System Access (DISA)

If you are working externally, the DISA function enables you to make external calls (long distance) via the company PBX. You only pay for the call to your company. See section "[Other Useful Features](#)" on page 78.

Directory number

Numbers with 1 – 8 digits which are assigned to extensions or external lines or as Common Abbreviated Numbers.

Diversion

Incoming calls to an extension are diverted to another directory number (extension, Common Abbreviated Number or the operator). There are three possibilities:

1. *Direct, which means that all calls to an extension are forwarded directly.*
2. *On no reply, which means that a call is forwarded if it is not answered within a certain time.*
3. *On busy, which means that a call is forwarded if the extension is busy.*

See section "[Call Forwarding](#)" on page 44.

Diversion Bypass

This is useful for letting urgent calls through to an extension where diversion is active. See section "[Call Forwarding](#)" on page 44.

Extension

All telephones connected to the PBX have a unique internal number (up to 8 digits). If your telephone is equipped with a display, you can see your number.

Function code

A digit code that corresponds to a specific function. See section “[Settings](#)” on page 87.

Hold

To put a call on hold. See section “[During Calls](#)” on page 33.

Information

Internal callers are informed about absence and time of return. External callers are diverted to the operator, where the same information is available. Information can be of two kinds:

1. *Pre-programmed text information.*
2. *Voice information.*

Intercom

A two-way direct call function between two extensions, for instance an executive-secretary communication. See section “[Other Useful Features](#)” on page 78.

Intrusion

To intrude on an ongoing call when a requested extension is busy. See section “[Outgoing Calls](#)” on page 22.

IP call

Internal call sent via an internal data network (LAN or WAN).

ISDN

Integrated Services Digital Network. Provides your system with supplementary services from the public net. See section “[ISDN Facilities](#)” on page 73.

Least Cost Routing

A function that automatically selects the cheapest way to connect your external call (not necessarily the shortest distance). See section “[Least Cost Routing](#)” on page 86.

Loudspeaker Paging

All members of an extension group are paged, i.e. receive a short, sharp tone on the loudspeaker followed by a Voice message from the sender. See section “[Group Features](#)” on page 68.

Mailbox

The Mailbox system controls the messages that are left for or sent by you when you are absent. See section “[Mailbox System](#)” on page 54.

Message

A message can be sent to any extension. This is useful when you receive the busy tone or get no answer. There are two kinds of message:

1. *Call Me message.*
2. *Voice message.*

See section “[Mailbox System](#)” on page 54.

Metering

Outgoing external calls can be metered on individual call meters or specified Account Numbers. See section “[Call Metering](#)” on page 42.

Mute

To switch the microphone temporarily off. See section “[During Calls](#)” on page 33.

Night Switching

Used for directing all incoming calls to one extension (answering position), for example when the office is closed. See section “[Other Useful Features](#)” on page 78.

Password

A four-digit code needed to e.g. block your extension and retrieve messages from the Mailbox system. You can set your own Password. See section “[Security](#)” on page 66.

PBX

Private Branch Exchange. Your telephone switching system (e.g. BusinessPhone 250).

Pre-defined text

Pre-programmed absent information.
See section "[Absence Information](#)" on page 50.

Third party

A third connection (person), which can be included in an ongoing two person conversation.
The connection can be internal or external.
See section "[During Calls](#)" on page 33.

Tie line

An external line from the private network.

Transfer

During an internal or external ongoing call you can make an inquiry and then transfer the call to another party (internal or external).
See section "[During Calls](#)" on page 33 and "[Useful Hints](#)" on page 104.

Trunk line

A trunk line is the same as an external line.
Can be either digital or analog.

Index

A

- Abbreviated Numbers 27
- Absence Information 50
 - Change information 52
 - Enter information 50
 - Receive information for diverted calls 53
- Access the mailbox 56
- Accessories 98
 - Extra handset 100
 - Headset 100
 - Tape recorder 100
- Account Number 83
- Activate the Mailbox 54
- Alternative programming for Automatic Callback, Camp-on, Intrusion 91
- Answer an incoming call from an ISDN-line 74
- Answer calls 19
- Audible Adjustments
 - Ringing signal 93
- Automatic Callback 24
- Automatic Redial 24

B

- Background Music 80
- Block extension 66
- Busy extension 26
- Bypass blocked extension 67

C

- Call Forwarding 44
 - Diversion when caller receives busy tone 44
 - Diversion when there is no answer 44
 - Fixed Diversion 45
 - Follow-me 49
 - Individual Diversion 47
 - Program Fixed Diversion address 46
- Call List 40
- Call Metering 42
 - Cost Indication 22

- Cost of the last call 43
 - Read out your own cost counter 43
- Call Waiting 36
- Change information 52
- Change Password
 - via the telephone 61
 - via your mailbox 61
- Change your Personal Greeting 58
- Common Abbreviated Numbers 29
- Common Bell 70
- Common Hold 38
- Conference 37
- Connections between external lines 104
- Conversation Recording 63
- Cost Indication 42
- Cost of the last call 43

D

- Deactivate the Mailbox 55
- Description 6
 - Display info 14
 - Lamp indications 13
 - Signals 17
 - Tones 16
- Dial-by-Name 31
- Dictaphone function 62
- Direct Inward System Access (DISA) 82
- Display contrast 97
- Display info 14
- Diversion when caller receives busy tone 44
- Diversion when there is no answer 44
- Diverted extension 27
- Doorphone 80
- DTMF Tones 84
- During Calls 33
 - Call Waiting 36
 - Common Hold 38
 - Conference 37
 - From handset to handsfree 33

- From handsfree to handset 34
- Group Listening 33
- Individual Hold 38
- Inquiry 34
- Mute 34
- Refer Back 35
- Transfer 35

E

- Enter information 50
- Expansion key panel 98
- Extra handset 100

F

- Fixed Diversion 45
- Follow-me 49
- Forward a Voice Message 58
- From handset to handsfree 33
- From handsfree to handset 34
- Function codes and required data 90

G

- Glossary 115
- Group Call-pick-up 69
- Group Features 68
 - Common Bell 70
 - Group Call-pick-up 69
 - Group Hunting 71
 - Key system 68
 - Loudspeaker Paging 70
 - Supervision/Telephone Attendance 69
- Group Hunting 71
- Group Listening 33

H

- Handset and loudspeaker volume 92
- Headset 100

I

- Immediate Answer 84
- Incoming Calls 18
 - Answer calls 19
 - Silent ringing 20
- Individual Abbreviated Numbers via a programmable key 29
- Individual Abbreviated Numbers via the keypad 30
- Individual Diversion 47
- Individual Hold 38
- Inquiry 34

- Installation Dialog 3211/12 112
 - Adjust 113
 - Cables 112
 - Cleaning 114
 - Placing 114
 - Stand 113
 - Wall mounting handset hook 113

- Installation Dialog 4222 105

- Adapt 106
- Cables 105
- Card 111
- Cleaning 111
- Placing 111
- Stands 106
- Wall mounting handset hook 110

- Intercom Line 81

- IP Calls 85

- ISDN Facilities 73

- Answer an incoming call from an ISDN-line 74
- Call List 40
- Make an external call on an ISDN-line 75
- Malicious Call Identification 76
- Number Identification 73
- Number Secrecy 77

K

- Key panel 98
- Key system 68

L

- Lamp indications 13
- Last External Number Redial 23
- Least Cost Routing 86
- Listen to your Messages 57
- Loudspeaker Paging 70

M

- Mailbox System 54
 - Access the mailbox 56
 - Activate the Mailbox 54
 - Change Password 61
 - Change your Personal Greeting 58
 - Deactivate the Mailbox 55
 - Dictaphone function 62
 - Forward a Voice Message 58
 - Listen to your Messages 57
 - Outcall (External) Notification 59
 - Send Messages via your mailbox 59
- Make a call via the System Phonebook 65

Make an external call on an ISDN-line 75
Make calls 22
Malicious Call Identification 76
Melody programming 94
Messages
 Conversation Recording 63
 Send Message 39
Mute 34

N

Networking 85
Night Switching 81
Number Identification 73
Number Secrecy 77

O

Option unit 98
Other Useful Features 78
 Account Number 83
 Background Music 80
 Direct Inward System Access (DISA) 82
 Doorphone 80
 Immediate Answer 84
 Intercom Line 81
 IP Calls 85
 Networking 85
 Night Switching 81
 Reminder 79
 Tandem configuration 78
Outcall (External) Notification 59
Outgoing Calls 22
 Automatic Callback 24
 Automatic Redial 24
 Busy extension 26
 Common Abbreviated Numbers 29
 Dial-by-Name 31
 Diverted extension 27
 Individual abbreviated numbers via a programmable key 29
 Individual Abbreviated Numbers via the keypad 30
 Last External Number Redial 23
 Make calls 22
 Save external number 23

P

Program a function 88

Program Fixed Diversion address 46

R

Read out your own cost counter 43
Receive information for diverted calls 53
Refer Back 35
Reminder 79
Ringing signal 93

S

Save and redial incoming calls 21
Save external number 23
Security 66
 Block extension 66
 Bypass blocked extension 67
Send Message 39
Send Messages
 via the mailbox 59
Settings 87
 Function codes and required data 90
 Melody programming 94
 Program a function 88
Signals 17
Silent ringing 20
Supervision/Telephone Attendance 69
System Phonebook
 Make a Call 65
 Use 64

T

Tandem configuration 78
Tape recorder 100
Tones 16
Transfer 35

U

Use the system Phonebook 64
Useful Hints 104
 Connections between external lines 104

V

Volume 92

W

Welcome 4

Subject to alteration without prior notice.
For questions regarding the product,
please contact your Aastra Certified Sales Partner.
Also visit us on www.aastra.com

© Aastra Telecom Sweden AB 2008. All rights reserved.
EN/LZTBS 170 321 R2A